

MONARCH 6035

60" x 35" x 20"

Monarch is a refined collection of therapeutic baths with distinctive Quartz deck surfaces, for a look that's noble and pure.

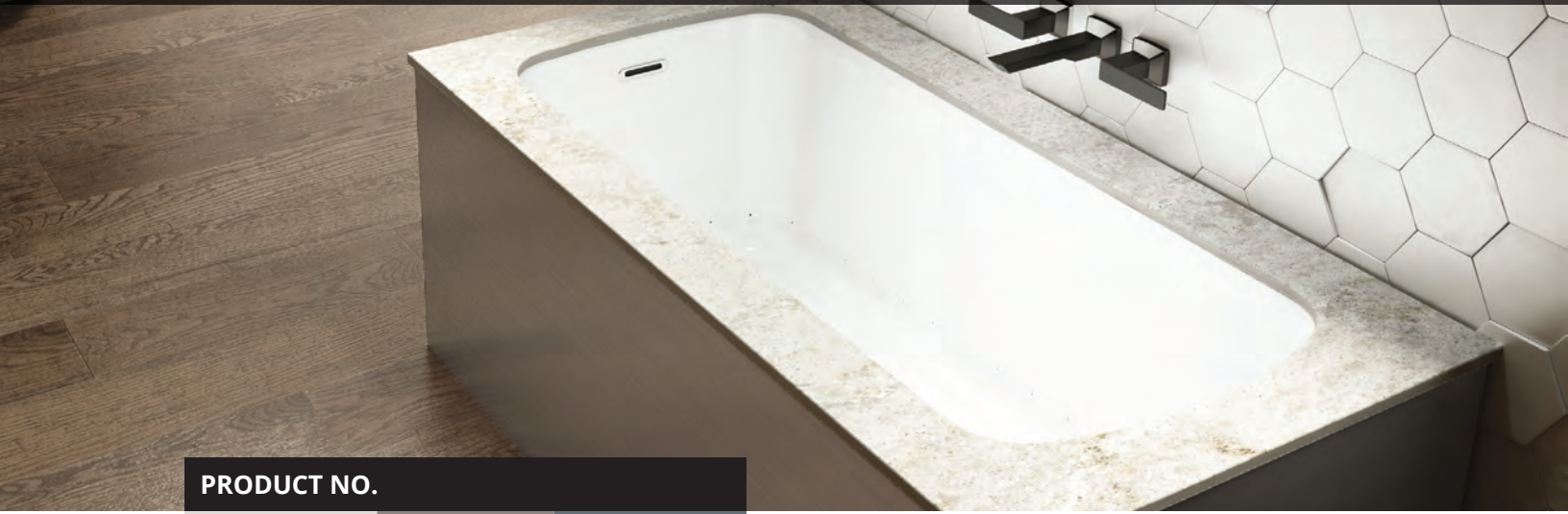

PRODUCT NO.

DESCRIPTION	TMU	TUB
Standard (S)*	BMO6RB00T-XX	BMO6RB00N-XX
Grand Luxury (GL)*	BML6RB00T-XX	BML6RB00N-XX

THERMOMASSEUR (TMU)

Hydro-thermo massage + Air jet system

S \$

GL \$

Jets	40
1 heated backrest	Included
MiaPlus® Control (not installed)	Included
BU-Touch Control Application BUTOUCH NEW	\$
Geysair®	Included
AromaCloud®	N/A
Illuzio Chromatherapy BCHRO6	\$

TUB

Soaker

S \$

GL \$

AromaCloud®	N/A
Illuzio Chromatherapy BCHRO6	\$
WarmTouchShell® BWTS	\$
DOT control	Included with therapy

FEATURES

Installation type	Drop-in & Alcove (3 walls)		
No. of bathers	↓	Imp. gallons	40
US gallons	48		

INTEGRATED WASTE & OVERFLOW **BOVERINI-XX**

White 01, Chrome 07, Brushed Nickel 09, Polished Nickel 10 Inst. & Incl.

STANDARD COLOR (inner shell)

	Included
White 01	

QUARTZ DECK COLOR

S* **BDMO6035-XX**

GL* **BDML6035-XX**

				Included	Included
Grey Expo 21	Noka 22	Jet Black 23	Lagos Blue 24		

OPTIONS (UPCHARGE APPLICABLE)





QUARTZ DECK COLOR

S*

BDMO6035-XX

GL*

BDML6035-XX

		\$	\$
Quasar Light 25			
			
Piatra Grey 26	Bianco Drift 31	Woodlands 30	
		\$	\$
Statuario Maximus 29			

FINISH (inner shell)

UltraVelour Matte Finish (White only) **BVEL** \$

INTEGRATED WASTE & OVERFLOW **BOVERINI-XX**

Matte Black 19, Black Chrome 12, Satin Brass 18 \$

WASTE & OVERFLOW 16" x 35" **BOVER16-XX**

Chrome 07	\$
White 01	\$
Brushed Nickel 09, Polished Nickel 10, Oil-rubbed Bronze 11	\$

QUARTZ SKIRT 6018 (60" x 18 7/8") **BSM6018-XX**

Grey Expo 21, Noka 22	\$
Jet Black 23, Lagos Blue 24	\$
Quasar Light 25	\$
Piatra Grey 26, Bianco Drift 31, Woodlands 30	\$
Statuario Maximus 29	\$

TILE FLANGE (specify right or left)

Ordered with bath (not installed) **BTILEN** \$

Factory-installed. Right **BTILER**, Left **BTILEL**, Special installation **BTILEO** \$

IF REQUIRED BY CONSTRUCTION CODE

Brass waste & overflow kit** BDRCOB	\$
Brass waste kit** BDRCB	\$
16" x 35" Cable driven brass waste & overflow kit BOVERBR-XX	\$

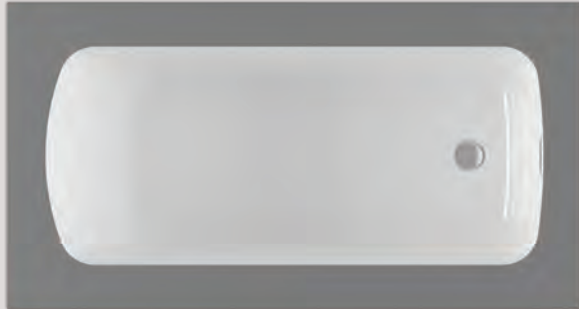

MONARCH 6035



Bianco Drift quartz deck

INSTALLATION

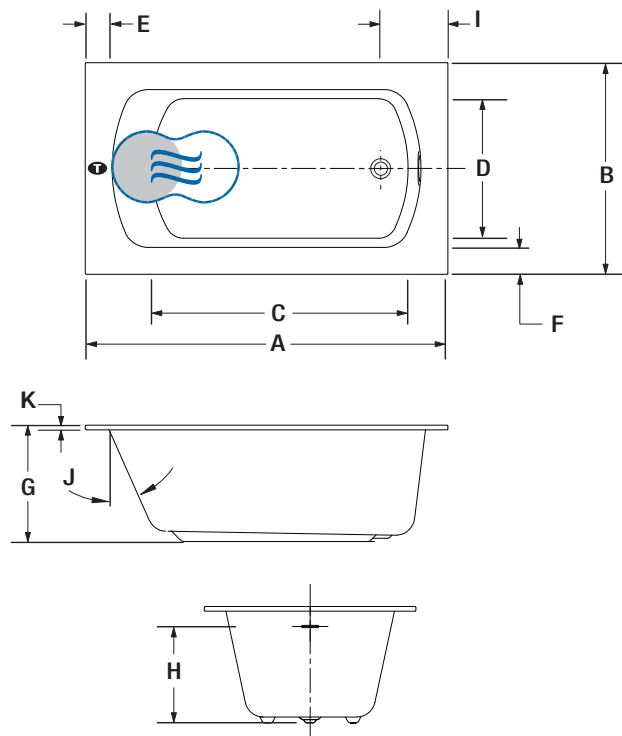

LETTER	DESCRIPTION	MEASURE
A	Total length	60"
B	Total width	35"
C	Bathing well length (at height of jets)	42 3/8"
D	Bathing well width (at height of jets)	22 3/4"
E	Deck width (edges)	4 5/8"
F	Deck width (sides)	4 5/8"
G	Bath height	19 7/8"
H	Height from drain to center of overflow	15 3/8"
I	Outside edge to center drain	11 1/8"
J	Slope of backrest	24°
K	Quartz deck height	3/4"

- T** Turbine position (TMU)
- Indicates heated backrest (TMU)
- Indicates WarmTouchShell® position (TUB)

⚡ Don't forget that this model is available in **White only with choice of quartz deck color**. Don't forget to specify the **finish of the integrated waste & overflow**.
 * Standard: Quartz deck with seam. Grand Luxury: one piece Quartz deck.
 ** When ordered with integrated waste & overflow.

TOTAL PRICE \$

TECHNICAL SPECIFICATIONS

Hot water supply required	Should be 70% of water capacity of TUB or greater.
Turbine	Access to the pump must be at least 18" x 22". Standard connection is 20 A. 120 V, 60 hz , dedicated line with a Ground-Fault Circuit Interrupter (GFCI). For any additional option, a second line is needed 15 A. 120 V, 60 hz , dedicated line with a GFCI.
Others	<ul style="list-style-type: none"> - The GEYSAIR must always be accessible and connected to the hot water supply (provide access). - Control cannot be installed on the Quartz deck. - Optional tile flange (specify right or left).

Our products must be installed by certified professionals only and according to our Monarch Installation Manual as well as federal, provincial/state and local building codes and regulations (www.bainultra.com/documentation/documentation).

Approx. shipping weight	240 lbs
Turbine power	550 W
Air heater	600 W
WARRANTY	
Controls-LED-Geysair*	5 years
Quartz deck*	15 years
Bath & turbine*	20 years

* Some restrictions apply | www.bainultra.com/warranty



The specifications shown indicate the outer edge dimension and the inside bathing capacity dimension measured at air jets' height. The manufacturer accepts a 1/4" [0.64 cm] variance. There are variations on each product and specifications are subject to change as we improve upon our product as required. The dimensions needed for site preparation and structure building will differ. BainUltra® assumes no responsibility for preparatory work done prior to the product being on site.