

PRODUCT SHEET
CHARISM 5736
 57" X 36" X 23"



THERMOMASSEUR® BATH	\$
TUB	\$

THERMOMASSEUR (TMU)	
Jets	35
1 heated backrest	included
MiaMulti® Control*	included
Geysair®	included
AromaCloud®	N/A
Illuzio Chromatherapy NEW	\$

TUB (soaker)	
AromaCloud®	N/A
Illuzio Chromatherapy NEW	\$
WarmTouchShell®	\$
DOT control	included with therapy

FEATURES			
Installation type	Freestanding		
No. of bathers	↓	Integrated waste & overflow	inst. & incl.
US gallons	49		
Imp. gallons	41		
INTEGRATED WASTE & OVERFLOW			
Chrome, White			
Brass, Brushed Nickel, Polished Nickel			

FEATURES	
COLOR	
Standard	
<input type="checkbox"/>	White
DECK COLOR	
Standard	
<input type="checkbox"/>	White
<input type="checkbox"/>	Black

OPTIONAL UPCHARGE APPLICABLE	
FINISH	
UltraVelour Matte Finish (White Only)	\$
DECK COLOR	
Optional	
<input type="checkbox"/>	Crystal Rock
<input type="checkbox"/>	Copper
	\$
ISLAND TUB DRAIN™**	
Island Tub Drain™	\$

DON'T FORGET THAT THIS MODEL IS AVAILABLE IN WHITE ONLY WITH CHOICE OF DECK COLOR. DON'T FORGET TO SPECIFY THE FINISH OF THE INTEGRATED WASTE & OVERFLOW.
 * CONTROL AND FAUCET CANNOT BE INSTALLED ON THE DECK OF THE BATH.
 **AN ISLAND TUB DRAIN IS REQUIRED WHEN THERE IS NO ACCESS UNDER THE BATH.

1 800 463.2187 info@bainultra.com | From 8 a.m. to 8 p.m. Monday to Thursday (EST)
 From 8 a.m. to 5 p.m. on Friday (EST)

CHARISM 5736 57" X 36" X 23"

ACCESSORIES (OPTIONAL)

CUTTING TEMPLATE

90000070

OTHERS

- Faucet must be freestanding or wall-mounted.
- The turbine must be remotely installed.
- Controls cannot be installed on the bath.

TOTAL PRICE

\$

FREESTANDING INSTALLATION

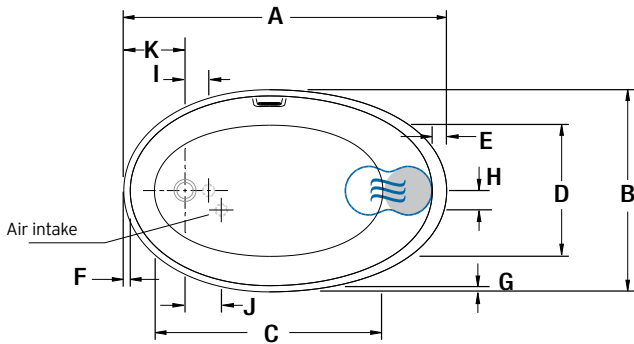

LETTER	DESCRIPTION	MEASURE
A	Total length	57 1/4"
B	Total width	35 7/8"
C	Bathing well length	41 1/2"
D	Bathing well width	23 7/8"
E	Deck width at headrest	2 5/8"
F	Deck width (waste end)	1 1/8"
G	Deck width	1 1/8"
H	Center tub waste to air intake	3 1/2"
I	Center tub waste to waste hole	4 1/4"
J	Center tub waste to air intake	6 1/2"
K	Tub outside edge to center tub waste	10 3/4"
L	Total height	23 1/4"
M	Slope at waste end	12°
N	Slope of backrest	31°
O	Base length	47 3/8"
P	Base width	26 7/8"
Q	Height from waste to center of overflow	16"

● Indicates heated backrest (TMU)

☞ Indicates WarmTouchShell position

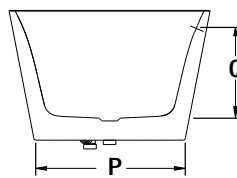
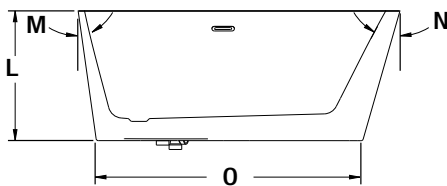

TECHNICAL SPECIFICATIONS

Hot water supply required Should be 70% of water capacity of tub or greater.

Turbine Access to the pump must be at least 18" X 22". **Standard connection is 20 A, 120 V, 60 hz**, dedicated line with a Ground-Fault Circuit Interrupter (GFCI). **For any additional option, a second line is needed 15 A, 120 V, 60 hz**, dedicated line with a GFCI. Air vent necessary: 2" X 4" minimum

Our products must be installed by certified professionals only and according to our Owner's Manual as well as federal, provincial/state and local building codes and regulations (www.bainultra.com/documentation/documentation).

Approx. shipping weight 210 lbs

Turbine power 550 W

Air heater 600 W

WARRANTY

Controls-LED-Geysair* 5 years

Bath & turbine* 20 years

*Some restrictions apply | www.bainultra.com/warranty



The specifications shown indicate the outer edge dimension and the inside bathing capacity dimension measured at air jets' height. The manufacturer accepts a 1/4" [0,64 cm] variance. There are variations on each product and specifications are subject to change as we improve upon our product as required. The dimensions needed for site preparation and structure building will differ. BainUltra® assumes no responsibility for preparatory work done prior to the product being on site.

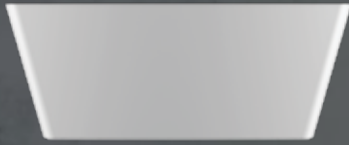

PRODUCT SHEET
CHARISM 6434
 64" X 34" X 24"



THERMOMASSEUR® BATH	\$
TUB	\$

THERMOMASSEUR (TMU)	
Jets	38
1 heated backrest	included
MiaMulti® Control*	included
Geysair®	included
AromaCloud®	N/A
Illuzio Chromatherapy NEW	\$
2 nd heated backrest (advanced technology)	\$

TUB (soaker)	
AromaCloud®	N/A
Illuzio Chromatherapy NEW	\$
WarmTouchShell®	\$
DOT control	included with therapy
2 nd WarmTouchShell®	\$

FEATURES			
Installation type	Freestanding		
No. of bathers		Integrated waste & overflow	inst. & incl.
US gallons	55		
Imp. gallons	46		
INTEGRATED WASTE & OVERFLOW			
Chrome, White			
Brass, Brushed Nickel, Polished Nickel			

FEATURES	
COLOR	
Standard	
<input type="checkbox"/>	White
DECK COLOR	
Standard	
<input type="checkbox"/>	White
<input type="checkbox"/>	Black

OPTIONAL UPCHARGE APPLICABLE	
FINISH	
UltraVelour Matte Finish (White Only)	\$
DECK COLOR	
Optional	
Crystal Rock	Copper
	\$
ISLAND TUB DRAIN™**	
Island Tub Drain™	\$

DON'T FORGET THAT THIS MODEL IS AVAILABLE IN WHITE ONLY WITH CHOICE OF DECK COLOR. DON'T FORGET TO SPECIFY THE FINISH OF THE INTEGRATED WASTE & OVERFLOW.
 * CONTROL AND FAUCET CANNOT BE INSTALLED ON THE DECK OF THE BATH.
 **AN ISLAND TUB DRAIN IS REQUIRED WHEN THERE IS NO ACCESS UNDER THE BATH.

1 800 463.2187 info@bainultra.com | From 8 a.m. to 8 p.m. Monday to Thursday (EST)
 From 8 a.m. to 5 p.m. on Friday (EST)

CHARISM 6434 64" X 34" X 24"

ACCESSORIES (OPTIONAL)

CUTTING TEMPLATE

90000068

OTHERS

- Faucet must be freestanding or wall-mounted.
- The turbine must be remotely installed.
- Controls cannot be installed on the deck of the bath.

TOTAL PRICE

\$

FREESTANDING INSTALLATION

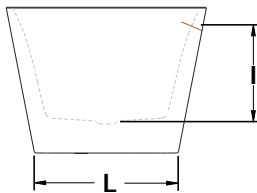
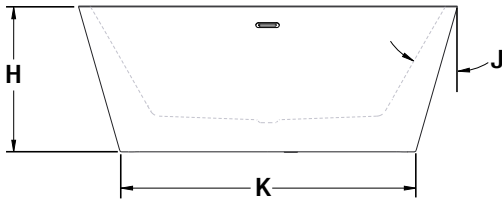
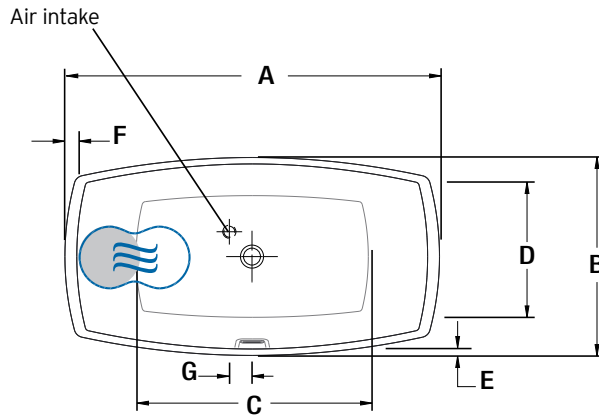

LETTER	DESCRIPTION	MEASURE
A	Total length	64 1/8"
B	Total width	33 7/8"
C	Bathing well length	41 7/8"
D	Bathing well width	21 1/2"
E	Deck width	1 1/8"
F	Deck width at headrest	1 7/8"
G	Center waste to air intake	3 7/8"
H	Total height	24 3/4"
I	Maximum water level	16"
J	Slope of backrest	31°
K	Base length	50"
L	Base width	24 1/4"

● Indicates heated backrest (TMU)

☞ Indicates WarmTouchShell position

TECHNICAL SPECIFICATIONS

Hot water supply required Should be 70% of water capacity of tub or greater.

Turbine Access to the pump must be at least 18" X 22". **Standard connection is 20 A, 120 V, 60 hz,** dedicated line with a Ground-Fault Circuit Interrupter (GFCI). **For any additional option, a second line is needed 15 A, 120 V, 60 hz,** dedicated line with a GFCI. Air vent necessary: 2" X 4" minimum

Our products must be installed by certified professionals only and according to our Owner's Manual as well as federal, provincial/state and local building codes and regulations (www.bainultra.com/documentation/documentation).

Approx. shipping weight	230 lbs
Turbine power	550 W
Air heater	600 W

WARRANTY

Controls-LED-Geysair*	5 years
Bath & turbine*	20 years

*Some restrictions apply | www.bainultra.com/warranty



The specifications shown indicate the outer edge dimension and the inside bathing capacity dimension measured at air jets' height. The manufacturer accepts a 1/4" [0,64 cm] variance. There are variations on each product and specifications are subject to change as we improve upon our product as required. The dimensions needed for site preparation and structure building will differ. BainUltra® assumes no responsibility for preparatory work done prior to the product being on site.

PRODUCT SHEET
CHARISM 6436
 64" X 36" X 24"



THERMOMASSEUR® BATH	\$
TUB	\$

THERMOMASSEUR (TMU)	
Jets	35
1 heated backrest	included
MiaMulti® Control*	included
Geysair®	included
AromaCloud®	N/A
Illuzio Chromatherapy NEW	\$
2 nd heated backrest (advanced technology)	\$

TUB (soaker)	
AromaCloud®	N/A
Illuzio Chromatherapy NEW	\$
WarmTouchShell®	\$
DOT control	included with therapy
2 nd WarmTouchShell®	\$

FEATURES			
Installation type	Freestanding		
No. of bathers	2	Integrated waste & overflow	inst. & incl.
US gallons	51		
Imp. gallons	42		
INTEGRATED WASTE & OVERFLOW			
Chrome, White			
Brass, Brushed Nickel, Polished Nickel			

FEATURES	
COLOR	
Standard	
<input type="checkbox"/>	White
DECK COLOR	
Standard	
<input type="checkbox"/>	White
<input type="checkbox"/>	Black

OPTIONAL UPCHARGE APPLICABLE	
FINISH	
UltraVelour Matte Finish (White Only)	\$
DECK COLOR	
Optional	
<input type="checkbox"/>	Crystal Rock
<input type="checkbox"/>	Copper
	\$
ISLAND TUB DRAIN™**	
Island Tub Drain™	\$

 **DON'T FORGET THAT THIS MODEL IS AVAILABLE IN WHITE ONLY WITH CHOICE OF DECK COLOR. DON'T FORGET TO SPECIFY THE FINISH OF THE INTEGRATED WASTE & OVERFLOW.**
 * CONTROL AND FAUCET CANNOT BE INSTALLED ON THE DECK OF THE BATH.
 **AN ISLAND TUB DRAIN IS REQUIRED WHEN THERE IS NO ACCESS UNDER THE BATH.

1 800 463.2187  From 8 a.m. to 8 p.m. Monday to Thursday (EST)
 info@bainultra.com From 8 a.m. to 5 p.m. on Friday (EST)

CHARISM 6436 64" X 36" X 24"

ACCESSORIES (OPTIONAL)

CUTTING TEMPLATE

90000067

OTHERS

- Faucet must be freestanding or wall-mounted.
- The turbine must be remotely installed.
- Controls cannot be installed on the bath.

TOTAL PRICE

\$

FREESTANDING INSTALLATION

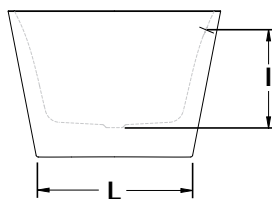
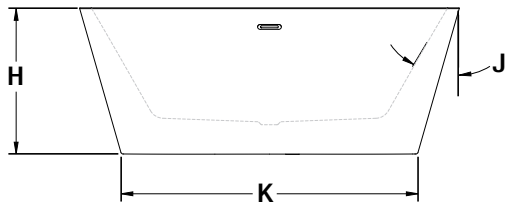
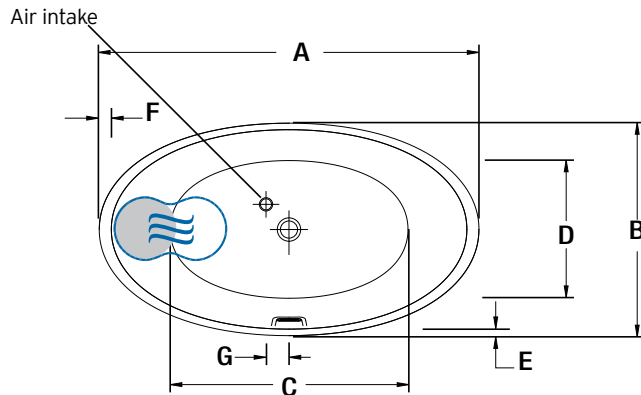

LETTER	DESCRIPTION	MEASURE
A	Total length	64 1/8"
B	Total width	35 7/8"
C	Bathing well length	41 3/4"
D	Bathing well width	23 5/8"
E	Deck width	1 1/8"
F	Deck width at headrest	2"
G	Center waste to air intake	3 7/8"
H	Total height	24 3/4"
I	Maximum water level	16"
J	Slope of backrest	31°
K	Base length	50"
L	Base width	26 1/4"

● Indicates heated backrest (TMU)

☰ Indicates WarmTouchShell position

TECHNICAL SPECIFICATIONS

Hot water supply required Should be 70% of water capacity of tub or greater.

Turbine Access to the pump must be at least 18" X 22". **Standard connection is 20 A, 120 V, 60 hz,** dedicated line with a Ground-Fault Circuit Interrupter (GFCI). **For any additional option, a second line is needed 15 A, 120 V, 60 hz,** dedicated line with a GFCI. Air vent necessary: 2" X 4" minimum

Our products must be installed by certified professionals only and according to our Owner's Manual as well as federal, provincial/state and local building codes and regulations (www.bainultra.com/documentation/documentation).

Approx. shipping weight 230 lbs

Turbine power 550 W

Air heater 600 W

WARRANTY

Controls-LED-Geysair* 5 years

Bath & turbine* 20 years

*Some restrictions apply | www.bainultra.com/warranty



The specifications shown indicate the outer edge dimension and the inside bathing capacity dimension measured at air jets' height. The manufacturer accepts a 1/4" [0,64 cm] variance. There are variations on each product and specifications are subject to change as we improve upon our product as required. The dimensions needed for site preparation and structure building will differ. BainUltra® assumes no responsibility for preparatory work done prior to the product being on site.