

PRODUCT SHEET
CITTI 6032 TRIO WITHOUT INSERT
 60" X 32" X 20"









THERMOMASSEUR® BATH	\$
THERMASENS® BATH	\$
TUB	\$

THERMOMASSEUR (TMU)	
Jets	44
1 heated backrest	included
Mia® Control	included
Geysair®	included
AromaCloud®	\$
Chromatherapy - 2 LED*	\$

THERMASENS (TMSU)		TUB
AromaCloud®	included	\$
Chromatherapy - 2 LED	included	\$
WarmTouchShell®	included	\$
DOT control	included	included with therapy

FEATURES			
Installation	Alcove (3 walls)		
No. of bathers	↓	Integrated tile flange	included
US gallons	53	Integrated waste & overflow	inst. & incl.
Imp. gallons	44		
INTEGRATED WASTE & OVERFLOW			
Chrome, White			
Brass, Brushed Nickel, Polished Nickel			

OPTIONAL UPCHARGE APPLICABLE		
COLOR		
Standard		
 White	 Biscuit	
Optional		
 Black	 Sandbar	 Gray
	\$	
FINISH		
UltraVelour Matte Finish (White Only)	\$	
SKIRT (STANDARD DECK ONLY) 1 1/2"		
Multifit	\$	
Optional Color	\$	
CONTROL (TMU ONLY)		
MiaMulti®	\$	
MiaPlus®*	\$	

 TURBINE MUST BE REMOTELY INSTALLED IN CERTAIN CONDITIONS. WITH THE AROMACLOUD AND/OR CONTROL ON THE DECK, A COMPLETE SHOWER DOOR CANNOT BE INSTALLED. **DON'T FORGET TO SPECIFY THE FINISH OF THE INTEGRATED WASTE & OVERFLOW.**
 * THE MIA PLUS CONTROL IS INCLUDED WHEN PURCHASING CHROMATHERAPY ON A TMU.

1 800 463.2187 
 info@bainultra.com

From 8 a.m. to 8 p.m. Monday to Thursday (EST)
 From 8 a.m. to 5 p.m. on Friday (EST)

CITTI 6032 TRIO WITHOUT INSERT 60" X 32" X 20"

ACCESSORIES (OPTIONAL)

OTHERS	- The turbine must be remotely installed. - Citti bathtubs include an integrated tile flange, specify left or right.
TOTAL PRICE	\$

ALCOVE INSTALLATION

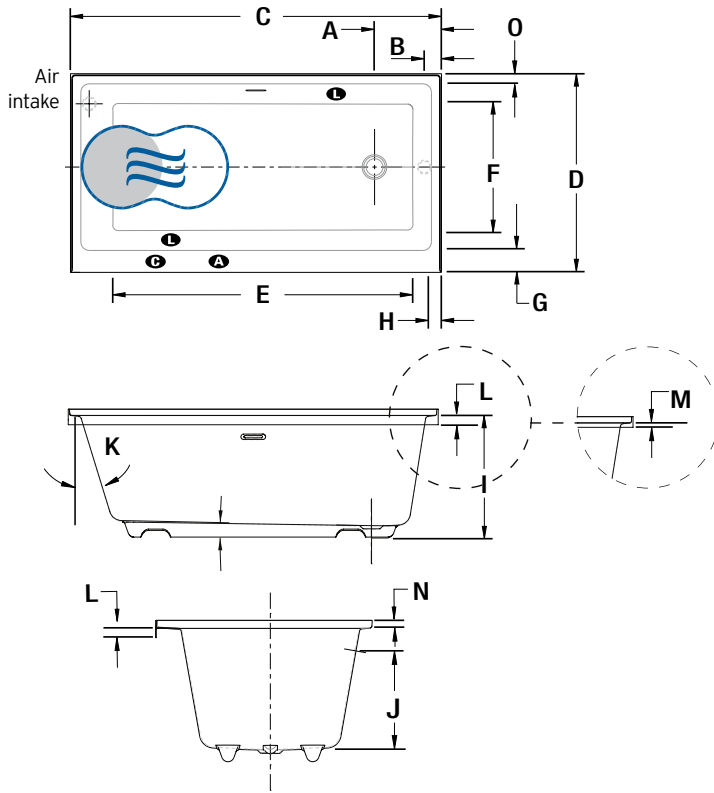

LETTER	DESCRIPTION	MEASURE
A	Outside edge to center drain	10 7/8"
B	Outside edge to centre of waste hole	2 3/4"
C	Total length	60"
D	Total width	32"
E	Bathing well length	49 1/4"
F	Bathing well width	21 1/8"
G	Deck width	3 3/4"
H	Deck width at waste end	2"
I	Height from bottom of tub to top deck	20"
J	Height from drain to center of overflow	14 1/2"
K	Slope of backrest	17°
L	Height from bottom of lip to top std deck	1 1/2"
M	Height from bottom of lip to top slim deck	1/2"
N	Tile flange height	1"
O	Deck width overflow side	2 1/8"

- L Indicates LED light position
- TMU Indicates heated backrest (TMU)
- TMSU Indicates WarmTouchShell position (TMSU)
- A Indicates AromaCloud position
- G Indicates control position when factory-installed (Mia or Dot)

TECHNICAL SPECIFICATIONS

Hot water supply required	Should be 70% of water capacity of tub or greater.
Turbine	Access to the pump must be at least 18" X 22". Standard connection is 20 A, 120 V, 60 hz , dedicated line with a Ground-Fault Circuit Interrupter (GFCI). For any additional option, a second line is needed 15 A, 120 V, 60 hz , dedicated line with a GFCI. Air vent necessary: 2" X 4" minimum

Our products must be installed by certified professionals only and according to our Owner's Manual as well as federal, provincial/state and local building codes and regulations (www.bainultra.com/documentation/documentation).

Approx. shipping weight	125 lbs
Turbine power	600 W
Air heater	700 W

WARRANTY

Controls-LED-Geysair*	5 years
Bath & turbine*	20 years

*Some restrictions apply | www.bainultra.com/warranty



The specifications shown indicate the outer edge dimension and the inside bathing capacity dimension measured at air jets' height. The manufacturer accepts a 1/4" [0,64 cm] variance. There are variations on each product and specifications are subject to change as we improve upon our product as required. The dimensions needed for site preparation and structure building will differ. BainUltra® assumes no responsibility for preparatory work done prior to the product being on site.