

MERIDIAN 6032

60" x 32" x 21"

Named after the meridians of our body—the paths along which our energy flows—the collection also brings to mind the meridian (or mid-point) of life with an invitation to relax and listen to your body and mind.

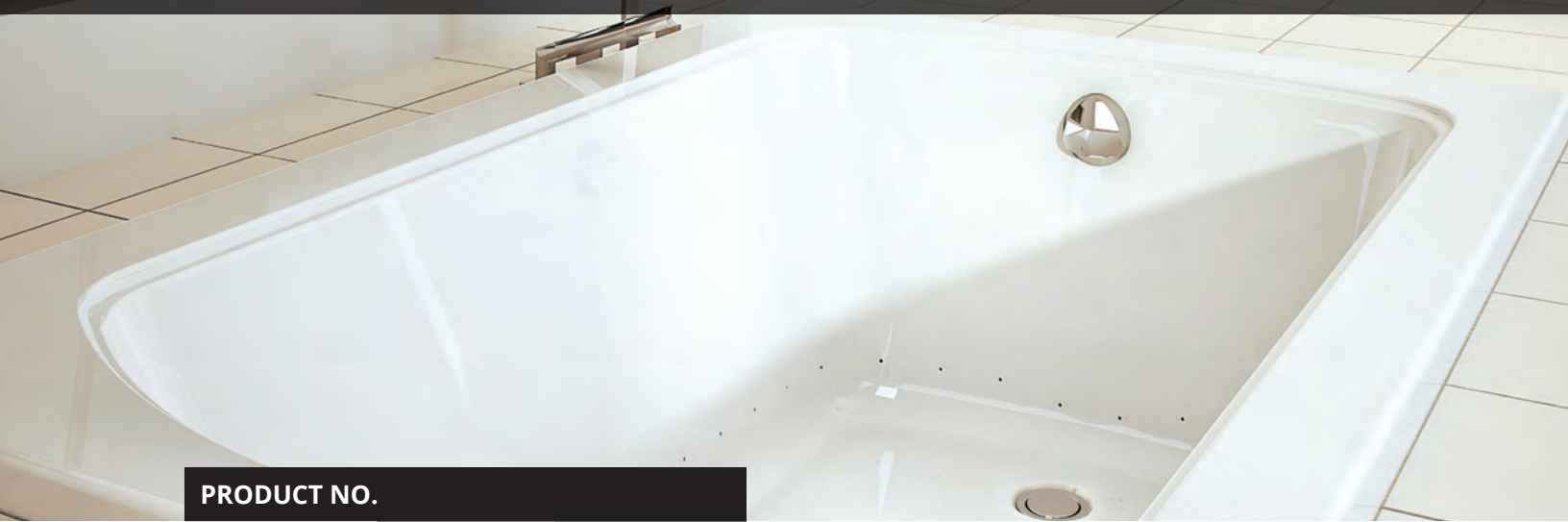



PRODUCT NO.

MODEL	TMU	TUB
Alcove - Right	BMEDRIORT-XX	BMEDRIORN-XX
Alcove - Left	BMEDRIOLT-XX	BMEDRIOLN-XX
Drop-in	BMEDRIO0T-XX	BMEDRIO0N-XX

THERMOMASSEUR (TMU)	
Hydro-thermo massage • Air jet system	\$
Jets	37
1 heated backrest	Included
MiaPlus® Control	Included
BU-Touch Control Application BUTOUCH	\$
Geysair®	Included
AromaCloud®** BAROMAC	\$
Illuzio Chromatherapy BCHRO6	\$

TUB	
Soaker	\$
AromaCloud®** BAROMAC	\$
Illuzio Chromatherapy BCHRO6	\$
WarmTouchShell® BWTS	\$
DOT control	Included with therapy

FEATURES

Installation type	Drop-in, Alcove (3 walls) & Undermount**		
No. of bathers	2		
US gallons	50	Integrated tile flange (specify right or left)	Included
Imp. gallons	41		
STANDARD COLOR			
 White 01  Biscuit 02	Included		

OPTIONS (UPCHARGE APPLICABLE)

WASTE & OVERFLOW 16" x 35" BOVER16-XX

Chrome 07	\$
White 01, Biscuit 02	\$
Brushed Nickel 09, Polished Nickel 10, Oil-rubbed Bronze 11	\$

SKIRT	MULTIFIT BSMUL-XX	SJ-1 BSJ1-XX
White 01, Biscuit 02	\$	\$

IF REQUIRED BY CONSTRUCTION CODE

16" x 35" Cable driven brass waste & overflow kit BOVERBR-XX	\$
--	----

 * The AromaCloud® is built into the deck (factory installed).
 ** The AromaCloud® is not available with Undermount installation.

TOTAL PRICE \$

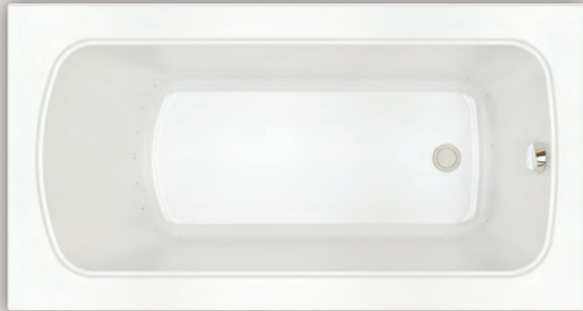

MERIDIAN 6032

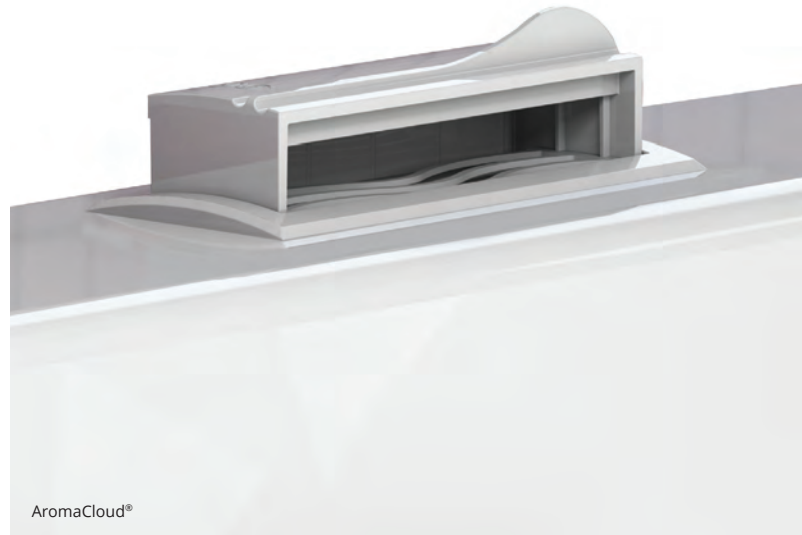

AromaCloud®

INSTALLATION

- A** When tile flange is added, the AromaCloud® will automatically be installed on the opposite side of the flange.

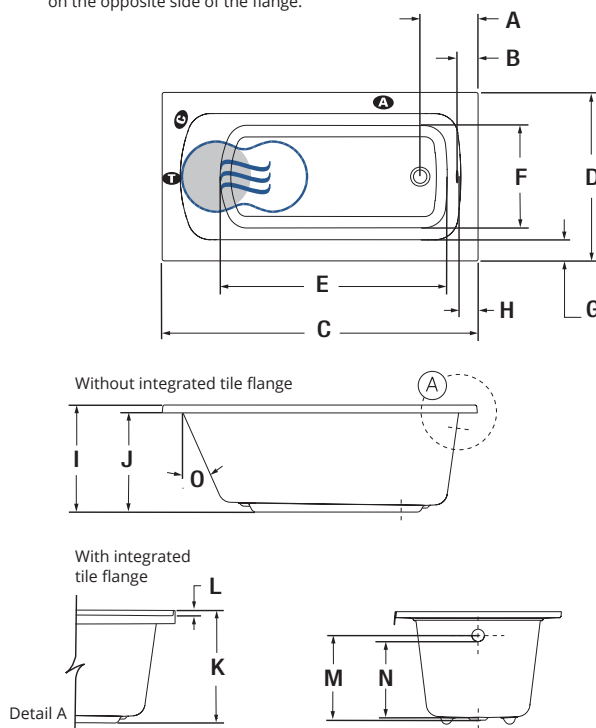

LETTER	DESCRIPTION	MEASURE
A	Outside edge to center drain	11"
B	Outside edge to overflow	4"
C	Total length	60"
D	Total width	32"
E	Bathing well length	43 5/8"
F	Bathing well width	19 5/8"
G	Deck width	4 1/4"
H	Deck width at drain end	3 1/2"
I	Height from bottom of bath to top deck	20 1/2"
J	Height from bottom of bath to bottom of deck	19"
K	Height from bottom of bath to top of tile flange	21 1/2"
L	Tile flange height	1"
M	Height from drain to center of overflow	16 1/8"
N	Maximum water level	14 3/8"
O	Slope of backrest	24°

- A** AromaCloud® position
- C** Control position when factory-installed (Mia® or DOT)
- T** Turbine position (TMU)
- Indicates heated backrest (TMU)
- ☄ Indicates WarmTouchShell® position (TUB)

TECHNICAL SPECIFICATIONS

Hot water supply required	Should be 70% of water capacity of TUB or greater.
Turbine	Access to the pump must be at least 18" x 22". Standard connection is 20 A, 120 V, 60 Hz , dedicated line with a Ground-Fault Circuit Interrupter (GFCI). For any additional option, a second line is needed 15 A, 120 V, 60 Hz , dedicated line with a GFCI. Air vent necessary: 2" x 4" minimum.
Others	- The GEYSAIR must always be accessible and connected to the hot water supply (provide access). - There is a height difference for the integrated tile flange (see Detail A).

Our products must be installed by certified professionals only and according to our Owner's Manual as well as federal, provincial/state and local building codes and regulations (www.bainultra.com/documentation/documentation).

Cutting template	# 90000053
Approx. shipping weight	100 lbs
Turbine power	550 W
Air heater	600 W

WARRANTY

Controls-LED-Geysair*	5 years
Bath & turbine*	20 years

* Some restrictions apply | www.bainultra.com/warranty



The specifications shown indicate the outer edge dimension and the inside bathing capacity dimension measured at air jets' height. The manufacturer accepts a 1/4" [0.64 cm] variance. There are variations on each product and specifications are subject to change as we improve upon our product as required. The dimensions needed for site preparation and structure building will differ. BainUltra® assumes no responsibility for preparatory work done prior to the product being on site.