

ELEGANCIA 7242

72" x 42" x 21"

With shapes and lines that take us back to the Victorian era, this collection transcends time, fitting right in with today's styles.

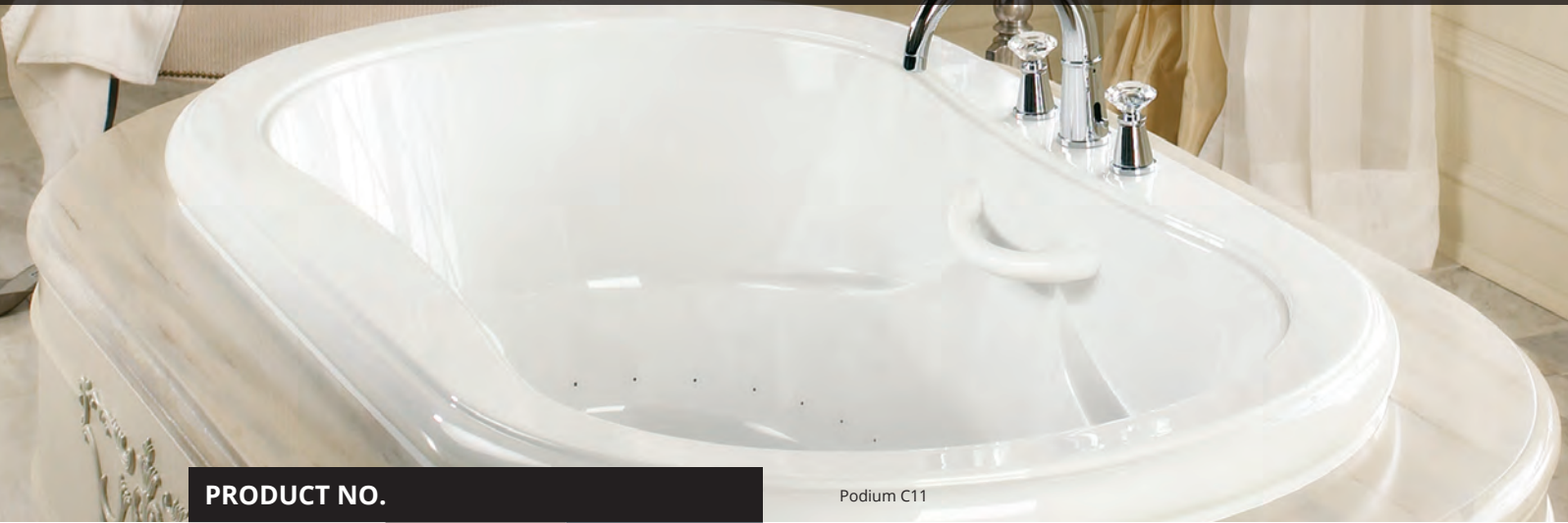



Podium C11

PRODUCT NO.

MODEL	TMU	TUB
C10	BELVRDA0T-XX	BELVRDA0N-XX
C11	BELVODB0T-XX	BELVODB0N-XX
C12	BELVRBC0T-XX	BELVRBC0N-XX
C13	BELVODD0T-XX	BELVODD0N-XX
C14	BELVODE0T-XX	BELVODE0N-XX

THERMOMASSEUR (TMU) Hydro-thermo massage • Air jet system	\$
Jets	40
1 heated backrest	Included
MiaPlus® Control	Included
BU-Touch Control Application BUTOUCH NEW	\$
Geysair®	Included
AromaCloud® BAROMAC	\$
Illuzio Chromatherapy BCHRO6	\$
2 nd heated backrest (WTS-1 zone) BSHB	\$

TUB Soaker	\$
AromaCloud® BAROMAC	\$
Illuzio Chromatherapy BCHRO6	\$
WarmTouchShell® BWTS	\$
DOT control	Included with therapy
2 nd WarmTouchShell® BWTS2	\$

FEATURES	
Installation type	Drop-in & Alcove (3 walls) for C12 only
No. of bathers	2
US gallons	60
Imp. gallons	50
STANDARD COLOR	
 White 01  Biscuit 02	Included

OPTIONS (UPCHARGE APPLICABLE)

SKIRT (with C12 only)	MULTIFIT BSMUL-XX	SJ-1 BSJ1-XX
White 01 , Biscuit 02	\$	\$
GRAB BARS	G11 METALLIC BGBG11-XX	CLEAR ACRYLIC* BGBG10-XX
Chrome 07	\$	\$
Brushed Nickel 09	\$	\$
Polished Nickel 10	\$	N/A
WASTE & OVERFLOW	D13 BOVERD13-XX	D14** BOVERD14-XX
Chrome 07	\$	\$
White 01 , Biscuit 02	N/A	\$
Brushed Nickel 09 , Polished Nickel 10	\$	\$
Unplated 00 , Oil-rubbed Bronze 11	\$	N/A
TILE FLANGE (for C12 contour only) (specify front or back)		
Ordered with bath (not installed) BTILEN		\$
Factory-installed. Front BTILEF , Back BTILEB , Special installation BTILEO		\$

 **Don't forget to select a contour among the 5 available to choose from.**
 * Specify insert finish. With Chrome or Brushed Nickel inserts.
 ** Piping is not included for this model (waste & overflow D14).

TOTAL PRICE \$



Contour C11

ELEGANCIA 7242

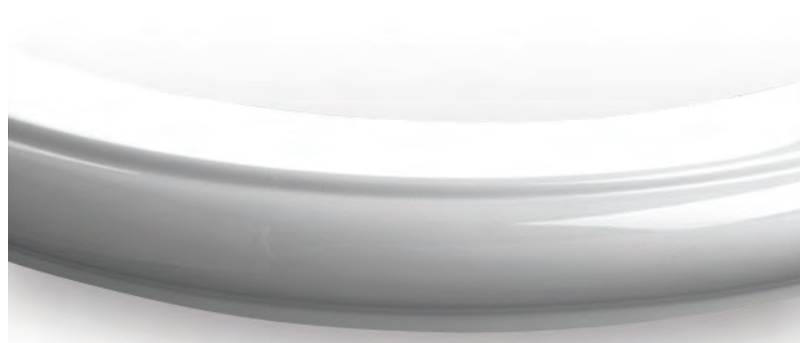

Contour C11

INSTALLATION

- A** When tile flange is added, the AromaCloud® will automatically be installed on the opposite side of the flange.

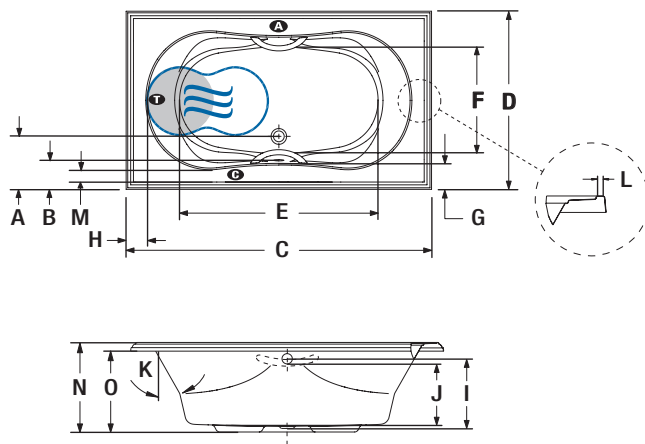

LETTER	DESCRIPTION	MEASURE
A	Outside edge to center drain	12 5/8"
B	Outside edge to overflow	6 5/8"
C	Total length	71 1/2"
D	Total width	41 1/2"
E	Bathing well length	47 1/4"
F	Bathing well width	25 3/8"
G	Deck width (widest point)	6 1/4"
H	Deck width at backrest end	5 1/8"
I	Height from drain to center of overflow	16"
J	Maximum water level	14 1/4"
K	Slope of backrests	30°
L	Flat contour width (narrowest point) C12 only	0 5/8"

- A** AromaCloud® position
B Control position when factory-installed (Mia® or DOT)
T Turbine position (TMU)
 ● Indicates heated backrest (TMU)
 ☄ Indicates WarmTouchShell® position (TUB)

CHOOSE YOUR CONTOUR

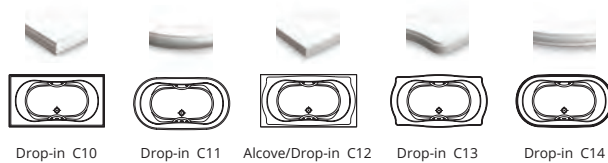

Drop-in C10 Drop-in C11 Alcove/Drop-in C12 Drop-in C13 Drop-in C14

LETTER	M	N	O
DESCRIPTION	Deck width (narrowest point)	Height from bottom of bath to top deck	Height from bottom of bath to bottom of lip
C10	2 5/8"	20 3/4"	18"
C11	2 7/8"	20 5/8"	17 1/8"
C12	1 7/8"	21"	19"
C13	2"	20 5/8"	18 5/8"
C14	2 1/2"	20 3/4"	18"

TECHNICAL SPECIFICATIONS

Hot water supply required	Should be 70% of water capacity of TUB or greater.
Turbine	Access to the pump must be at least 18" x 22". Standard connection is 20 A, 120 V, 60 Hz , dedicated line with a Ground-Fault Circuit Interrupter (GFCI). For any additional option, a second line is needed 15 A, 120 V, 60 Hz , dedicated line with a GFCI. Air vent necessary: 2" x 4" minimum.
Others	- The GEYSAIR must always be accessible and connected to the hot water supply (provide access). - Optional tile flange for C12 contour (specify front or back).

Our products must be installed by certified professionals only and according to our Owner's Manual as well as federal, provincial/state and local building codes and regulations (www.bainultra.com/documentation/documentation).

Cutting template	# 90000041 (C11, C13 & C14)
Approx. shipping weight	141 lbs
Turbine power	550 W
Air heater	600 W
WARRANTY	
Controls-LED-Geysair*	5 years
Bath & turbine*	20 years

* Some restrictions apply | www.bainultra.com/warranty



The specifications shown indicate the outer edge dimension and the inside bathing capacity dimension measured at air jets' height. The manufacturer accepts a 1/4" [0.64 cm] variance. There are variations on each product and specifications are subject to change as we improve upon our product as required. The dimensions needed for site preparation and structure building will differ. BainUltra® assumes no responsibility for preparatory work done prior to the product being on site.