

# MONARCH 6036

60" x 36" x 20"

Monarch is a refined collection of therapeutic baths with distinctive Quartz deck surfaces, for a look that's noble and pure.

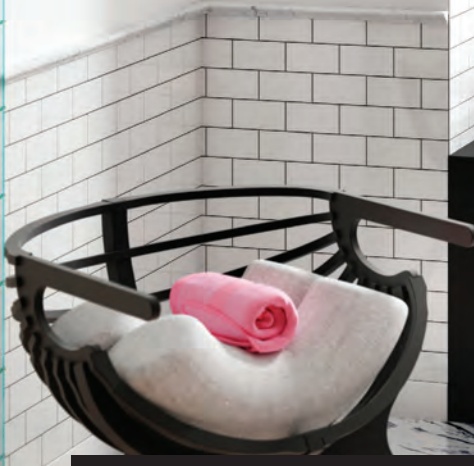

## PRODUCT NO.

DESCRIPTION	TMU	TUB
Standard (S)*	BMOFRB00T-XX	BMOFRB00N-XX
Grand Luxury (GL)*	BMLFRB00T-XX	BMLFRB00N-XX

### THERMOMASSEUR (TMU)

Hydro-thermo massage + Air jet system

S \$

GL \$

Jets	40
1 heated backrest	Included
MiaPlus® Control (not installed)	Included
BU-Touch Control Application <b>BUTOUCH NEW</b>	\$
Geysair®	Included
AromaCloud®	N/A
Illuzio Chromatherapy <b>BCHRO6</b>	\$

### TUB

Soaker

S \$

GL \$

AromaCloud®	N/A
Illuzio Chromatherapy <b>BCHRO6</b>	\$
WarmTouchShell® <b>BWTS</b>	\$
DOT control	Included with therapy

### FEATURES

Installation type	Drop-in & Alcove (3 walls)		
No. of bathers	↓	Imp. gallons	40
US gallons	48		

### INTEGRATED WASTE & OVERFLOW **BOVERINI-XX**

White 01, Chrome 07, Brushed Nickel 09, Polished Nickel 10 Inst. & Incl.

### STANDARD COLOR (inner shell)

	Included
White 01	

### QUARTZ DECK COLOR

S\*

GL\*

BDMO6036-XX BDML6036-XX

				Included	Included
Grey Expo 21	Noka 22	Jet Black 23	Lagos Blue 24		





### OPTIONS (UPCHARGE APPLICABLE)

#### QUARTZ DECK COLOR

S\*

GL\*

BDMO6036-XX BDML6036-XX

	\$	\$		
Quasar Light 25				
			\$	\$
Piatra Grey 26	Bianco Drift 31	Woodlands 30		
	\$	\$		
Statuario Maximus 29				

#### FINISH (inner shell)

UltraVelour Matte Finish (White only) **BVEL** \$

#### INTEGRATED WASTE & OVERFLOW **BOVERINI-XX**

Matte Black 19, Black Chrome 12, Satin Brass 18 \$

#### WASTE & OVERFLOW 16" x 35" **BOVER16-XX**

Chrome 07	\$
White 01	\$
Brushed Nickel 09, Polished Nickel 10, Oil-rubbed Bronze 11	\$

#### QUARTZ SKIRT 6018 (60" x 18 7/8") **BSM6018-XX**

Grey Expo 21, Noka 22	\$
Jet Black 23, Lagos Blue 24	\$
Quasar Light 25	\$
Piatra Grey 26, Bianco Drift 31, Woodlands 30	\$
Statuario Maximus 29	\$

#### TILE FLANGE (specify right or left)

Ordered with bath (not installed) **BTILEN** \$

Factory-installed. Right **BTILER**, Left **BTILEL**, Special installation **BTILEO** \$

#### IF REQUIRED BY CONSTRUCTION CODE

Brass waste & overflow kit** <b>BDRCOB</b>	\$
Brass waste kit** <b>BDRCB</b>	\$
16" x 35" Cable driven brass waste & overflow kit <b>BOVERBR-XX</b>	\$

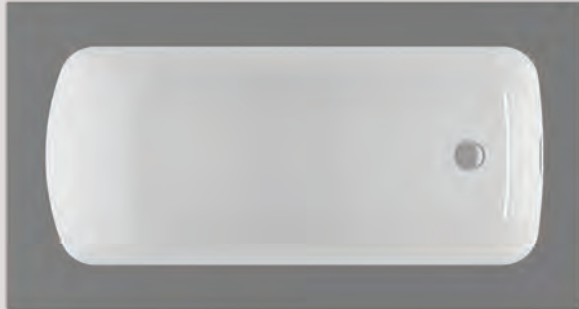

**MONARCH 6036**



Bianco Drift quartz deck

**INSTALLATION**

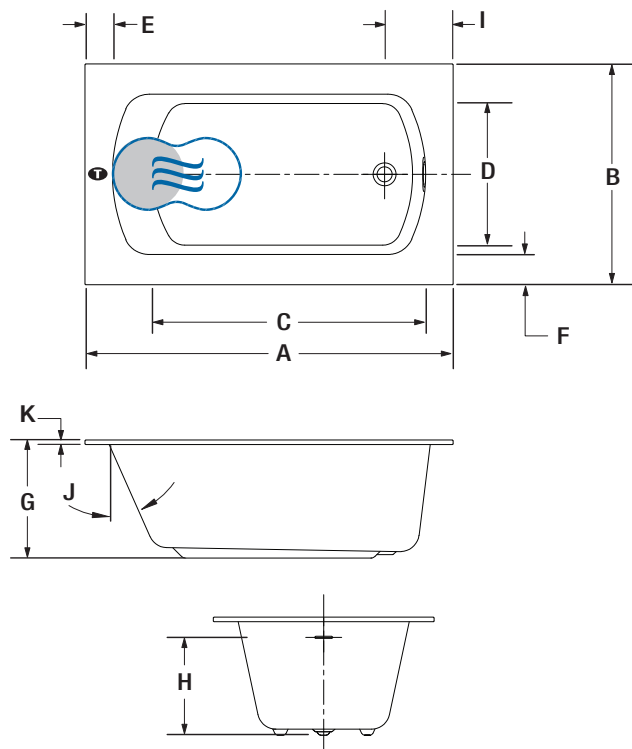

LETTER	DESCRIPTION	MEASURE
A	Total length	60"
B	Total width	36"
C	Bathing well length (at height of jets)	42 3/8"
D	Bathing well width (at height of jets)	22 3/4"
E	Deck width (edges)	4 5/8"
F	Deck width (sides)	5 1/8"
G	Bath height	19 7/8"
H	Height from drain to center of overflow	15 3/8"
I	Outside edge to center drain	11 1/8"
J	Slope of backrest	24°
K	Quartz deck height	3/4"

- T** Turbine position (TMU)
- Indicates WarmTouchShell® position (TUB)
- Indicates heated backrest (TMU)

Don't forget that this model is available in **White only with choice of quartz deck color**. Don't forget to specify the **finish of the integrated waste & overflow**.  
 \* Standard: Quartz deck with seam. Grand Luxury: one piece Quartz deck.  
 \*\* When ordered with integrated waste & overflow.

**TOTAL PRICE**      \$

**TECHNICAL SPECIFICATIONS**

<b>Hot water supply required</b>	Should be 70% of water capacity of TUB or greater.
<b>Turbine</b>	Access to the pump must be at least 18" x 22". <b>Standard connection is 20 A, 120 V, 60 hz</b> , dedicated line with a Ground-Fault Circuit Interrupter (GFCI). <b>For any additional option, a second line is needed 15 A, 120 V, 60 hz</b> , dedicated line with a GFCI.
<b>Others</b>	- <b>The GEYSAIR must always be accessible and connected to the hot water supply (provide access).</b> - Control cannot be installed on the Quartz deck. - Optional tile flange (specify right or left).

Our products must be installed by certified professionals only and according to our Monarch Installation Manual as well as federal, provincial/state and local building codes and regulations ([www.bainultra.com/documentation/documentation](http://www.bainultra.com/documentation/documentation)).

<b>Approx. shipping weight</b>	244 lbs
<b>Turbine power</b>	550 W
<b>Air heater</b>	600 W

WARRANTY	
Controls-LED-Geysair*	5 years
Quartz deck*	15 years
Bath & turbine*	20 years

\* Some restrictions apply | [www.bainultra.com/warranty](http://www.bainultra.com/warranty)



The specifications shown indicate the outer edge dimension and the inside bathing capacity dimension measured at air jets' height. The manufacturer accepts a 1/4" [0.64 cm] variance. There are variations on each product and specifications are subject to change as we improve upon our product as required. The dimensions needed for site preparation and structure building will differ. BainUltra® assumes no responsibility for preparatory work done prior to the product being on site.