



PRODUCT SHEET
THALASSA 55
 66" X 33" X 19"







THERMOMASSEUR® BATH	\$
THERMASENS® BATH	\$
TUB	\$

THERMOMASSEUR (TMU)	
Jets	40
1 heated backrest	included
Mia® Control	included
Geysair®	included
AromaCloud®	\$
Chromatherapy - 2 LED*	\$

THERMASENS (TMSU)		TUB
AromaCloud®	included	\$
Chromatherapy - 2 LED	included	\$
WarmTouchShell®	included	\$
DOT control	included	included with therapy

FEATURES			
Installation	Drop-in or Alcove (3 walls)		
No. of bathers	↓	Armrests	2
US gallons	50	Grab bars (color match)	2
Imp. gallons	41		

OPTIONAL UPCHARGE APPLICABLE		
COLOR		
Standard		
		
White	Biscuit	
Optional		
		
Black	Sandbar	Gray
		\$
CONTROL (TMU ONLY)		
MiaPlus®*		\$
MiaMulti®		\$
SKIRT	MULTIFIT	SJ-1
Skirt	\$	\$
Optional color	\$	\$
CLEAR ACRYLIC GRAB BARS		
With Chrome, Brass or Brushed nickel inserts		\$
WASTE & OVERFLOW		
		16" X 35"
Chrome		\$
White & Biscuit		\$
Brass		\$
Brushed nickel, Polished nickel & Oil-rubbed bronze		\$
TILE FLANGE		
Ordered with bath, uninstalled		\$
Factory-installed		\$



SPECIFY COLOR FOR THE CONTROL, WHITE OR BISCUIT.
 * THE MIA PLUS CONTROL IS INCLUDED WHEN PURCHASING CHROMATHERAPY ON A TMU.

1 800 463.2187  info@bainultra.com | From 8 a.m. to 8 p.m. Monday to Thursday (EST)
 From 8 a.m. to 5 p.m. on Friday (EST)

THALASSA 55 66" X 33" X 19"

ACCESSORIES (OPTIONAL)

OTHER

Optional tile flange (specify right or left).

TOTAL PRICE

\$

DROP-IN/ALCOVE INSTALLATION

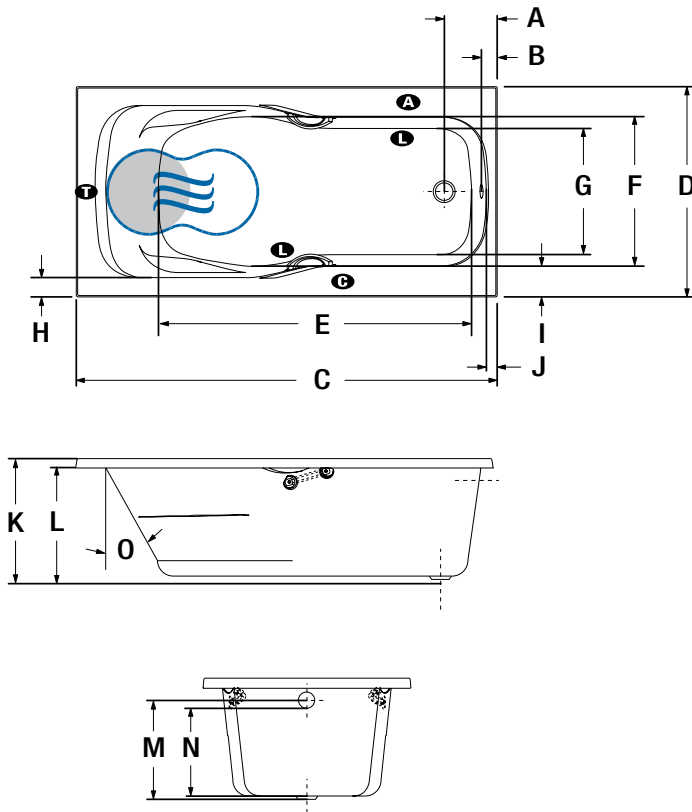

LETTER	DESCRIPTION	MEASURE
A	Outside edge to center drain	8"
B	Outside edge to overflow	2 1/4"
C	Total length	65 3/4"
D	Total width	32 7/8"
E	Bathing well length	49"
F	Bathing well width at seat area	23 1/8"
G	Bathing well width at foot area	19 7/8"
H	Deck width (narrowest point)	3 1/4"
I	Deck width (widest point)	5"
J	Deck width at drain end	2 1/8"
K	Height from bottom of tub to top deck	19 1/2"
L	Height from bottom of tub to bottom of lip	18"
M	Height from drain to center of overflow	15 5/8"
N	Maximum water level	13 3/4"
O	Slope of backrest	29°

- T** Indicates turbine position (TMU)
- L** Indicates LED light position
- C** Indicates heated backrest (TMU)
- C** Indicates control position when factory-installed
- W** Indicates WarmTouchShell position (TMSU)
- A** Indicates AromaCloud position

When tiling flange is added, the AromaCloud will automatically be installed on the opposite side of the flange.

TECHNICAL SPECIFICATIONS

Hot water supply required Should be 70% of water capacity of tub or greater.

Turbine Access to the pump must be at least 18" X 22". **Standard connection is 20 A, 120 V, 60 hz,** dedicated line with a Ground-Fault Circuit Interrupter (GFCI). **For any additional option, a second line is needed 15 A, 120 V, 60 hz,** dedicated line with a GFCI. Air vent necessary: 2" X 4" minimum

Our products must be installed by certified professionals only and according to our Owner's Manual as well as federal, provincial/state and local building codes and regulations (www.bainultra.com/documentation/documentation).

Approx. shipping weight 126 lbs

Turbine power 755 W

Air heater 700 W

WARRANTY

Controls-LED-Geysair* 5 years

Bath & turbine* 20 years

*Some restrictions apply | www.bainultra.com/warranty



The specifications shown indicate the outer edge dimension and the inside bathing capacity dimension measured at air jets' height. The manufacturer accepts a 1/4" [0.64 cm] variance. There are variations on each product and specifications are subject to change as we improve upon our product as required. The dimensions needed for site preparation and structure building will differ. BainUltra® assumes no responsibility for preparatory work done prior to the product being on site.